

### Description:

Fiber optic splice closure is an equipment that used for optical fiber cable splicing, joint and protection. It is water proof and dust proof and suitable for outdoor aerial hanged, pole mounted, wall mounted, duct, buried application.

CV016 is widely applied to the splicing, distributing variable optical cables. It is big capacity, max. 288 fibers.



### Features:

- 1) Splice tray: Max. 12pcs, each 24cores
- 2) Cable port: 6pcs round port  $\phi 19.9\text{mm}$ , 1pc oval port 38x70mm for supporting cable entry without cutting. All cable ports are heat shrink sealing.
- 3) Waterproof: IP68
- 4) Wall-mounting, aerial hanger and pole holding
- 5) Material: high impact resistance PP materials with UV

### Specification

Model	Splice tray	Fiber core	Dimension(mm)	Net weight(Kg)
CV016	12 trays, each 24 fibers	288 fibers	$\Phi 267 \times 527.5$	3.31

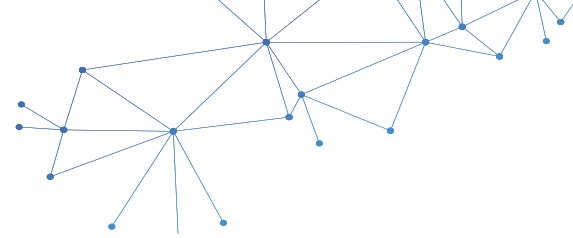

## Drawings (mm)

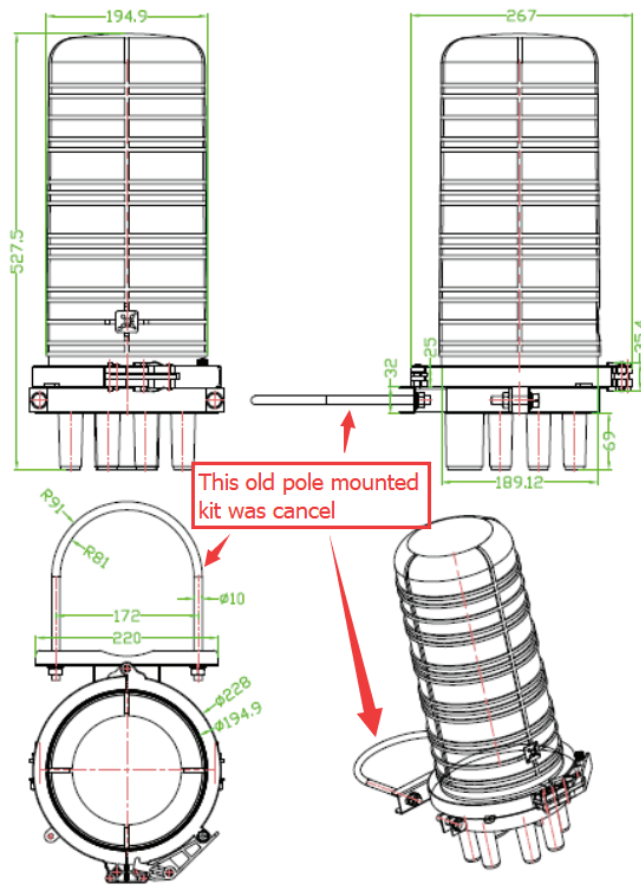





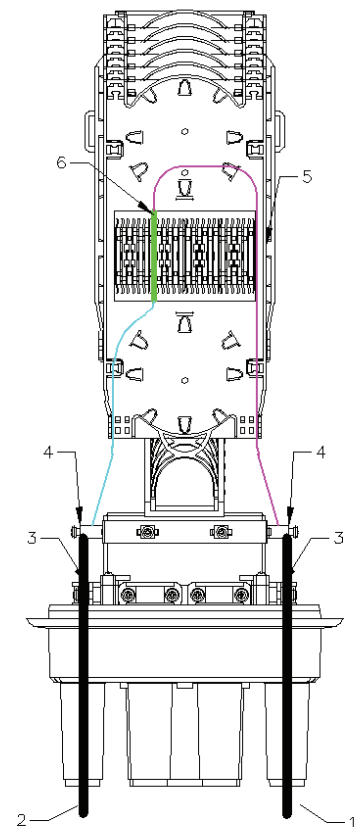

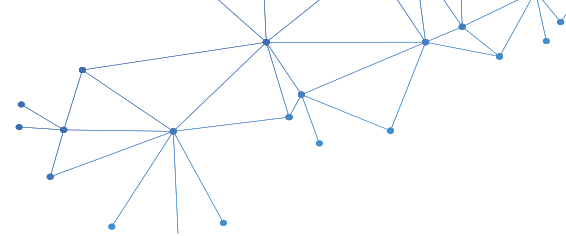
## Fiber cable installation drawing:

- 1-Cable input & output port
- 2-Cable input & output port
- 3--Wire pressing card
- 4--Cable fixing post
- 5-splice tray
- 6--protect splice sleeve



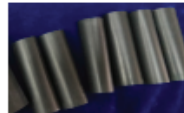
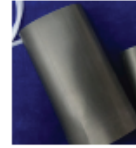

## Standard accessories:

Standard accessories list ( Outdoor aerial hanged)				
Item	Name	description	picture	Qty(pcs)
1	Plastic tube	Outer $\phi$ 5mm,0.6mm thickness/plastic/white/0.8M		1
2	Plastic tie	3mm*120mm/white		10
3	Splice sleeve	60mm*3.0*1.5	 Qty according to the order	288
4	Heat shrink tube	$\phi$ 30*100mm/black (remark :Inner wall spiral coating)		6
5	Heat shrink tube	$\phi$ 60*150mm/black (remark :Inner wall spiral coating)		1
6	Cable splitter	Small size		1
7	Insulating tape	0.15*17mm*8yard/black		1
8	PE plastic bag	12cm*17cm/transparent		1
9	Aerial hand kit	4 screw+ 4 nut+ 2 metal hook+2 flat washer+2 spring washer		1

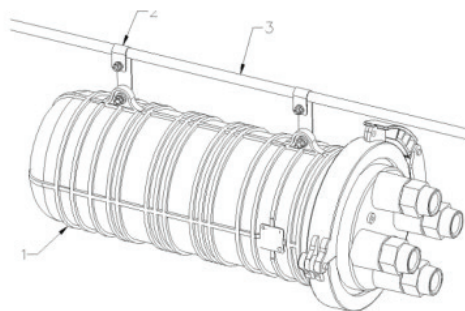

1— closure 2-- Aerial hanged accessory 3— steel wire



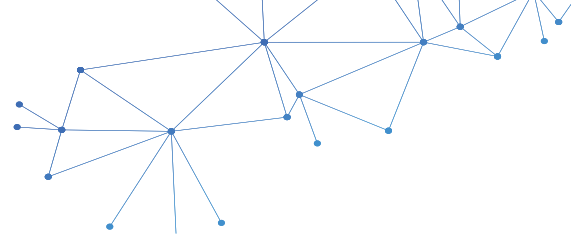

Optional accessories as following, but need extra charge if need:

A, Wall mount kit

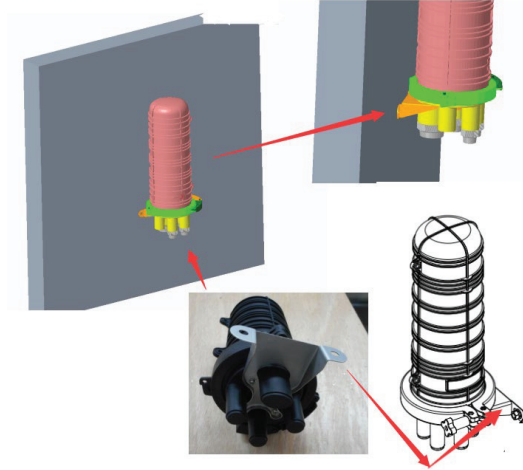

B, Pole mounted kit

